

OVERVIEW

The 5076 series are miniature VCXO ICs that provide a wide frequency pulling range, even when using miniature crystal units for which a wide pulling range is difficult to provide. They employ a recently developed varicap diode fabrication process that provides a wide frequency pulling range and good linearity without any external components. Also, they employ a regulated voltage drive oscillator circuit that significantly reduces current consumption, crystal current, and oscillation characteristics supply voltage dependency. The 5076 series are ideal for miniature, wide pulling range, low power consumption, VCXO modules.

FEATURES

- VCXO with recently developed varicap diode built-in
- New fabrication process that significantly reduces parasitic capacitance and provides wide pulling range even when using miniature crystal units
- Regulated voltage drive oscillator circuit for reduced power consumption, crystal drive current, and oscillation characteristics voltage dependency
- Wide frequency pulling range
 - $\pm 160\text{ppm}$ (B1 version, $f = 27\text{MHz}$)
(Crystal: $\gamma = 300$, $C_0 = 1.5\text{pF}$)
- Operating supply voltage range: 1.6V to 2.0V
- Oscillation frequency range (for fundamental oscillation): 20MHz to 55MHz (varies with version)
- Low current consumption: 0.5mA
(B1 version, $f = 27\text{MHz}$, no load, $V_{DD} = 1.8\text{V}$)
- Frequency divider built-in
 - Selectable by version: f_O , $f_O/2$, $f_O/4$, $f_O/8$, $f_O/16$
 - Frequency divider output for 1.3MHz (min) low frequency output
- VC pin input resistance: $10\text{M}\Omega$ (min)
- CMOS output
- Two types of pad layout selectable by mounting method
 - A \times version: for Flip Chip Bonding
 - B \times version: for Wire Bonding
- Package: Wafer form (WF5076 $\times\times$)
Chip form (CF5076 $\times\times$)

APPLICATIONS

- $2.5 \times 2.0\text{mm}$, $3.2 \times 2.5\text{mm}$ size miniature VCXO modules for digital mobile TV tuner, digital TV (PDP, LCD), PND (Personal Navigation Device), etc.

ORDERING INFORMATION

Device	Package
WF5076 $\times\times$ -4	Wafer form
CF5076 $\times\times$ -4	Chip form

PAD LAYOUT

(Unit: μm)

■ 5076A \times (for Flip Chip Bonding)

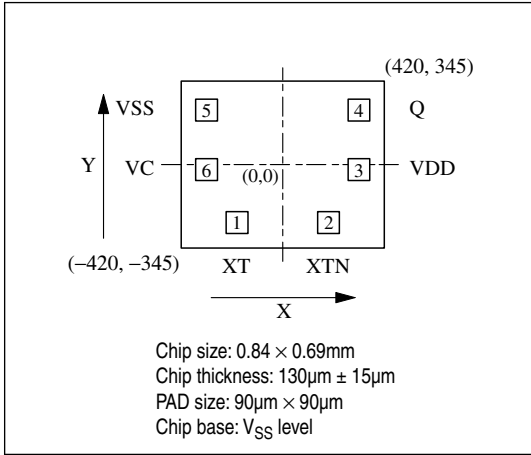

■ 5076B \times (for Wire Bonding)

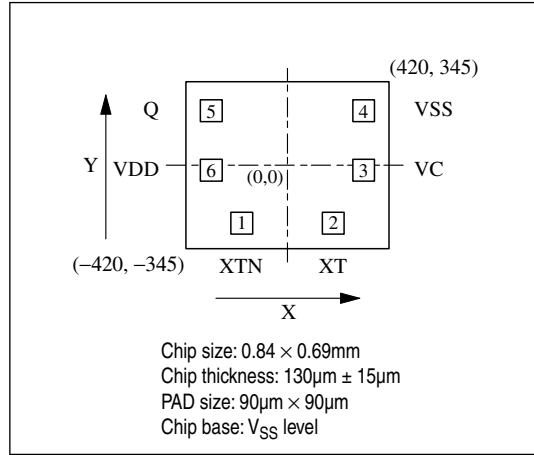

PAD DIMENSIONS PIN DESCRIPTION

Pad No.	Pad dimensions [μm]		Pad No.		Pin	I/O	Description
	X	Y	5076A \times	5076B \times			
1	-189	-240	1	2	XT	I	Crystal connection pin (amplifier input)
2	189	-240	2	1	XTN	O	Crystal connection pin (amplifier output)
3	315	-21	3	6	VDD	-	(+) supply pin
4	315	225	4	5	Q	O	Clock output pin
5	-315	225	5	4	VSS	-	(-) supply pin
6	-315	-21	6	3	VC	I	Oscillation frequency control voltage input pin (positive polarity) (frequency increases with increasing voltage)

BLOCK DIAGRAM

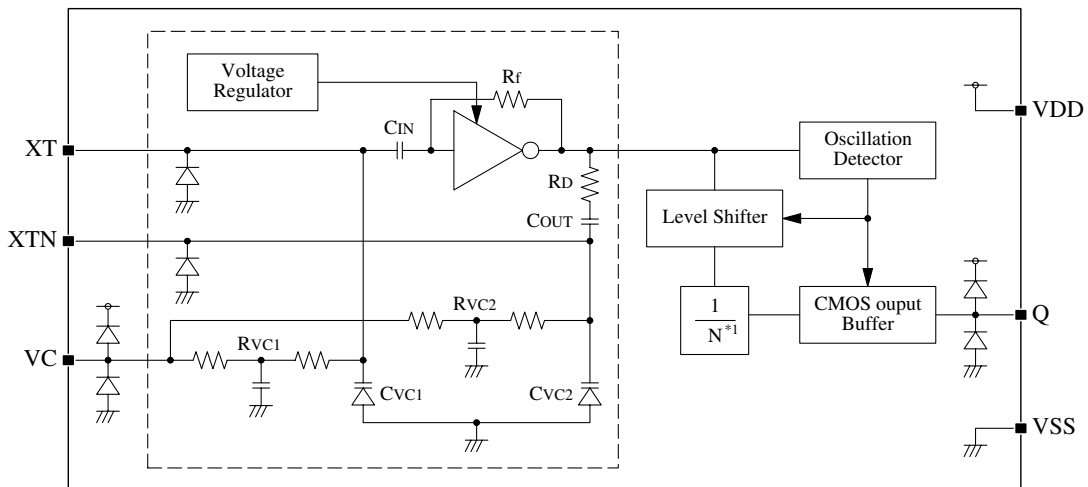

*1. N = 1, 2, 4, 8, 16

ABSOLUTE MAXIMUM RATINGS

$$V_{SS} = 0V$$

Parameter	Symbol	Conditions	Rating	Unit
Supply voltage range	V_{DD}	Between VDD and VSS	-0.5 to +5.0	V
Input voltage range ^{*1}	V_{IN}	Input pins	-0.5 to $V_{DD} + 0.5$	V
Output voltage range ^{*1}	V_{OUT}	Output pins	-0.5 to $V_{DD} + 0.5$	V
Storage temperature range	T_{STG}	Wafer form, chip form	-65 to +150	°C
Output current	I_{OUT}	Q pin	± 20	mA

*1. V_{DD} is a V_{DD} value of recommended operating conditions.

Note. Absolute maximum ratings are the values that must never exceed even for a moment. This product may suffer breakdown if any one of these parameter ratings is exceeded. Operation and characteristics are guaranteed only when the product is operated at recommended supply voltage range.

RECOMMENDED OPERATING CONDITIONS

$$V_{SS} = 0V$$

Parameter	Symbol	Conditions	Rating			Unit	
			Min	Typ	Max		
Operating supply voltage	V_{DD}	$C_{LOUT} \leq 15pF$	1.6	-	2.0	V	
Input voltage	V_{IN}	VC pin	V_{SS}	-	V_{DD}	V	
Operating temperature	T_{OPR}		-40	-	+85	°C	
Oscillation frequency ^{*1}	f_O	5076×1 to 5076×5	20	-	40	MHz	
		5076×J to 5076×N	40	-	55	MHz	
Output frequency	f_{OUT}	$C_{LOUT} \leq 15pF$	5076×1 to 5076×5	1.25	-	40	MHz
			5076×J to 5076×N	2.5	-	55	MHz

*1. The oscillation frequency is a yardstick value derived from the crystal used for NPC characteristics authentication. However, the oscillation frequency range is not guaranteed. Specifically, the characteristics can vary greatly due to crystal characteristics and mounting conditions, so the oscillation characteristics of components must be carefully evaluated.

Note. Mount a ceramic chip capacitor that is larger than 0.01 μ F proximal to IC (within approximately 3mm) between VDD and VSS in order to obtain stable operation of 5076 series. In addition, the wiring pattern between IC and capacitor should be as wide as possible.

ELECTRICAL CHARACTERISTICS

5076×1 to 5076×5

$V_{DD} = 1.6$ to $2.0V$, $V_C = 0.5V_{DD}$, $V_{SS} = 0V$, $T_a = -40$ to $+85^\circ C$ unless otherwise noted.

Parameter	Symbol	Conditions	Rating			Unit	
			Min	Typ	Max		
Current consumption	I_{DD}	5076×1 (f_O), Measurement circuit 1, no load, $f_O = 27MHz$, $f_{OUT} = 27MHz$, $V_{DD} = 1.8V$	–	0.5	1.0	mA	
		5076×2 ($f_O/2$), Measurement circuit 1, no load, $f_O = 27MHz$, $f_{OUT} = 13.5MHz$, $V_{DD} = 1.8V$	–	0.4	0.8	mA	
		5076×3 ($f_O/4$), Measurement circuit 1, no load, $f_O = 27MHz$, $f_{OUT} = 6.75MHz$, $V_{DD} = 1.8V$	–	0.3	0.6	mA	
		5076×4 ($f_O/8$), Measurement circuit 1, no load, $f_O = 27MHz$, $f_{OUT} = 3.38MHz$, $V_{DD} = 1.8V$	–	0.3	0.6	mA	
		5076×5 ($f_O/16$), Measurement circuit 1, no load, $f_O = 27MHz$, $f_{OUT} = 1.69MHz$, $V_{DD} = 1.8V$	–	0.3	0.6	mA	
HIGH-level output voltage	V_{OH}	Q pin, Measurement circuit 2, $I_{OH} = -2.0mA$	$V_{DD} - 0.4$	–	–	V	
LOW-level output voltage	V_{OL}	Q pin, Measurement circuit 2, $I_{OL} = 2.0mA$	–	–	0.4	V	
Oscillator block built-in resistance	R_{VC1}	Measurement circuit 3	210	420	840	k Ω	
	R_{VC2}		210	420	840	k Ω	
Oscillator block built-in capacitance	C_{VC1}	Design value (a monitor pattern on a wafer is tested), Excluding parasitic capacitance.	$V_C = 0.2V$	–	4.7	–	pF
			$V_C = 0.9V$	–	2.9	–	pF
			$V_C = 1.6V$	–	1.7	–	pF
	C_{VC2}		$V_C = 0.2V$	–	4.7	–	pF
			$V_C = 0.9V$	–	2.9	–	pF
			$V_C = 1.6V$	–	1.7	–	pF
VC input resistance	R_{VIN}	Measurement circuit 4, $T_a = 25^\circ C$	10	–	–	M Ω	
Modulation characteristics*1	fm	Measurement circuit 5, –3dB frequency, $V_{DD} = 1.8V$, $V_C = 1.8V_{p-p}$, $T_a = 25^\circ C$, $f_O = 27MHz$	–	100	–	kHz	

*1. The modulation characteristics may vary with the crystal used.

5076 series

5076×J to 5076×N

$V_{DD} = 1.6$ to $2.0V$, $V_C = 0.5V_{DD}$, $V_{SS} = 0V$, $T_a = -40$ to $+85^\circ C$ unless otherwise noted.

Parameter	Symbol	Conditions	Rating			Unit	
			Min	Typ	Max		
Current consumption	I_{DD}	5076×J (f_O), Measurement circuit 1, no load, $f_O = 48MHz$, $f_{OUT} = 48MHz$, $V_{DD} = 1.8V$	–	0.9	1.8	mA	
		5076×K ($f_O/2$), Measurement circuit 1, no load, $f_O = 48MHz$, $f_{OUT} = 24MHz$, $V_{DD} = 1.8V$	–	0.6	1.2	mA	
		5076×L ($f_O/4$), Measurement circuit 1, no load, $f_O = 48MHz$, $f_{OUT} = 12MHz$, $V_{DD} = 1.8V$	–	0.5	1.0	mA	
		5076×M ($f_O/8$), Measurement circuit 1, no load, $f_O = 48MHz$, $f_{OUT} = 6MHz$, $V_{DD} = 1.8V$	–	0.4	0.8	mA	
		5076×N ($f_O/16$), Measurement circuit 1, no load, $f_O = 48MHz$, $f_{OUT} = 3MHz$, $V_{DD} = 1.8V$	–	0.4	0.8	mA	
HIGH-level output voltage	V_{OH}	Q pin, Measurement circuit 2, $I_{OH} = -2.0mA$	$V_{DD} - 0.4$	–	–	V	
LOW-level output voltage	V_{OL}	Q pin, Measurement circuit 2, $I_{OL} = 2.0mA$	–	–	0.4	V	
Oscillator block built-in resistance	R_{VC1}	Measurement circuit 3	210	420	840	k Ω	
	R_{VC2}		210	420	840	k Ω	
Oscillator block built-in capacitance	C_{VC1}	Design value (a monitor pattern on a wafer is tested), Excluding parasitic capacitance.	$V_C = 0.2V$	–	4.7	–	pF
			$V_C = 0.9V$	–	2.9	–	pF
			$V_C = 1.6V$	–	1.7	–	pF
	C_{VC2}		$V_C = 0.2V$	–	4.7	–	pF
			$V_C = 0.9V$	–	2.9	–	pF
			$V_C = 1.6V$	–	1.7	–	pF
VC input resistance	R_{VIN}	Measurement circuit 4, $T_a = 25^\circ C$	10	–	–	M Ω	
Modulation characteristics*1	fm	Measurement circuit 5, –3dB frequency, $V_{DD} = 1.8V$, $V_C = 1.8V_{p-p}$, $T_a = 25^\circ C$, $f_O = 48MHz$	–	35	–	kHz	

*1. The modulation characteristics may vary with the crystal used.

SWITCHING CHARACTERISTICS

$V_{DD} = 1.6$ to $2.0V$, $V_C = 0.5V_{DD}$, $V_{SS} = 0V$, $T_a = -40$ to $+85^\circ C$ unless otherwise noted.

Parameter	Symbol	Conditions	Rating			Unit
			Min	Typ	Max	
Output rise time	t_r	Measurement circuit 6, $0.2V_{DD} \rightarrow 0.8V_{DD}$, $C_{LOUT} = 15pF$	–	3.1	6.0	ns
Output fall time	t_f	Measurement circuit 6, $0.8V_{DD} \rightarrow 0.2V_{DD}$, $C_{LOUT} = 15pF$	–	3.1	6.0	ns
Output duty cycle	Duty	Measurement circuit 6, $T_a = 25^\circ C$, $C_{LOUT} = 15pF$, $V_{DD} = 1.8V$	45	50	55	%

Switching Time Measurement Waveform

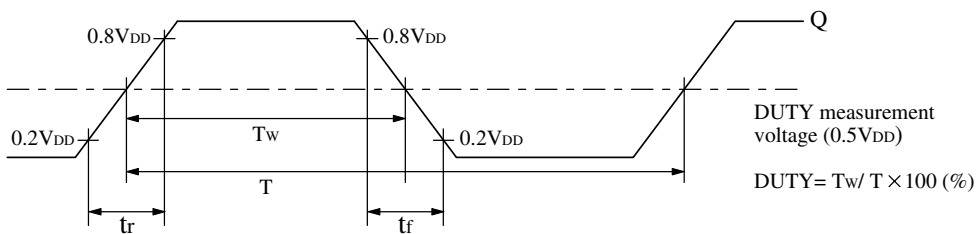

MEASUREMENT CIRCUITS

Measurement Circuit 1

Measurement parameter: I_{DD}

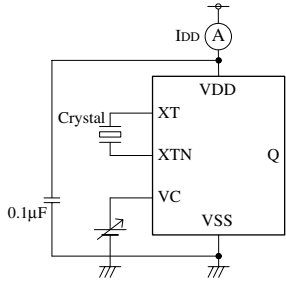

Measurement Circuit 4

Measurement parameter: R_{VIN}

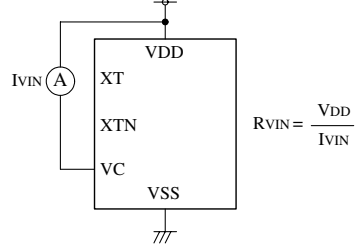

Measurement Circuit 2

Measurement parameter: V_{OH} , V_{OL}

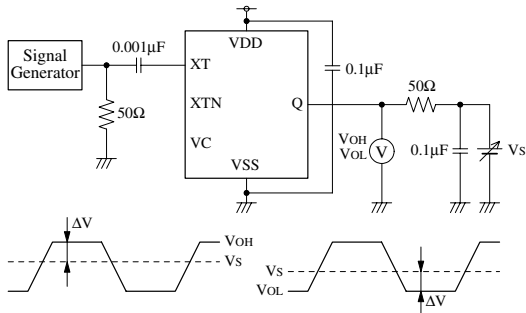

V_S adjusted such that $\Delta V = 50 \times I_{OH}$.

V_S adjusted such that $\Delta V = 50 \times I_{OL}$.

XT input signal: 1Vp-p, sine wave

Measurement Circuit 3

Measurement parameter: R_{VC1} , R_{VC2}

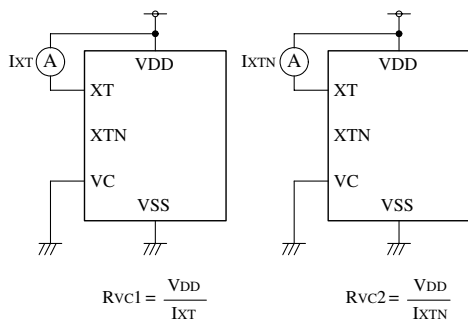

Measurement Circuit 5

Measurement parameter: fm

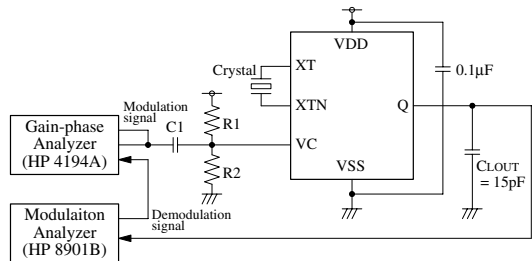

$C1 = 33\mu F$, $R1 = R2 = 1M\Omega$

VC modulation signal: 100Hz to 100kHz, 0 to V_{DDP-p}

Measurement Circuit 6

Measurement parameter: Duty, t_r , t_f

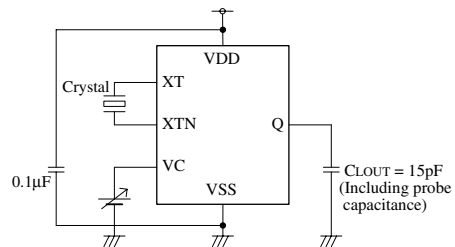

FUNCTIONAL DESCRIPTION

Oscillation Start-up Detector Function

The devices also feature an oscillation start-up detector circuit. This circuit functions to disable the outputs until the oscillation starts. This prevents unstable oscillator output at oscillator start-up when power is applied.

TYPICAL PERFORMANCE (5076B1)

The following characteristics measured using the crystal below. Note that the characteristics will vary with the crystal used.

■ Crystal used for measurement

Parameter	$f_0 = 27\text{MHz}$
C_0 [pF]	1.5
$\gamma (= C_0/C_1)$	300

■ Crystal equivalent circuit

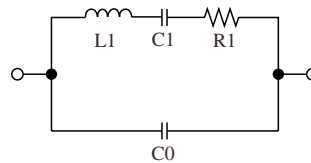

Frequency Pulling Range

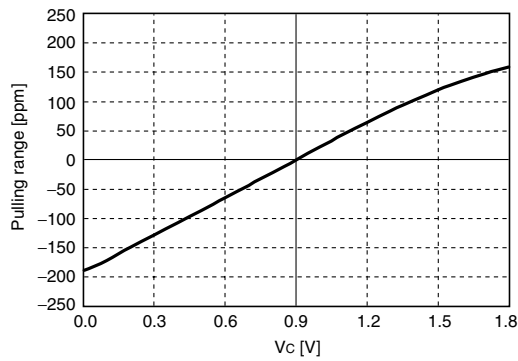

$V_{DD} = 1.8\text{V}$, $f_{OUT} = 27\text{MHz}$, $T_a = \text{R.T.}$

Pulling Sensitivity

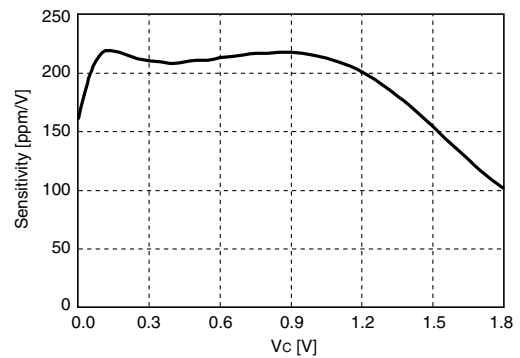

$V_{DD} = 1.8\text{V}$, $f_{OUT} = 27\text{MHz}$, $T_a = \text{R.T.}$

Measurement circuit

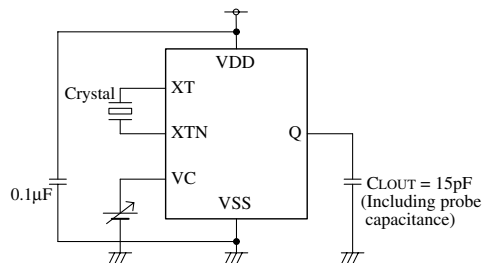

Current Consumption

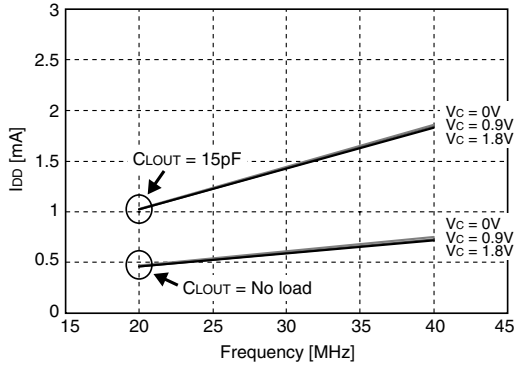

$V_{DD} = 1.8V, T_a = R.T.$

Measurement circuit

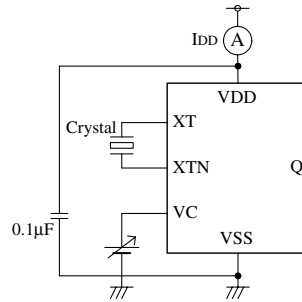

Frequency Stability by Supply Voltage Change

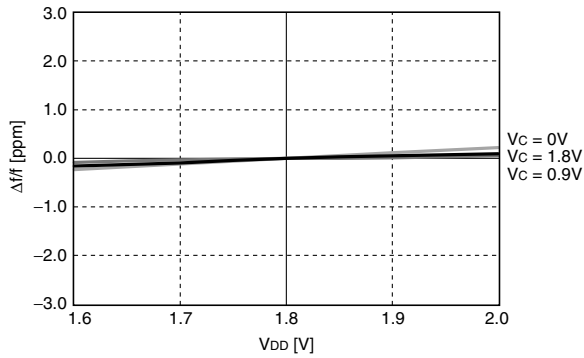

$f_{OUT} = 27MHz, \pm 0ppm \text{ at } V_{DD} = 1.8V, T_a = R.T.$

Measurement circuit

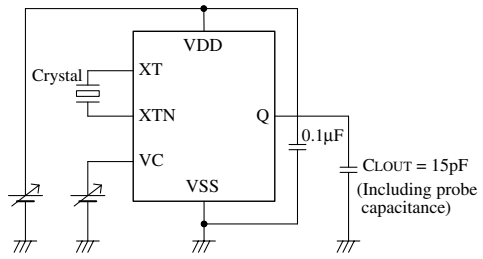

Drive Level

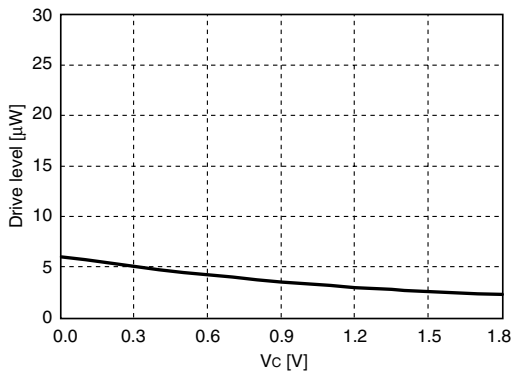

$V_{DD} = 1.8V, f_{OUT} = 27MHz, T_a = R.T.$

Measurement circuit

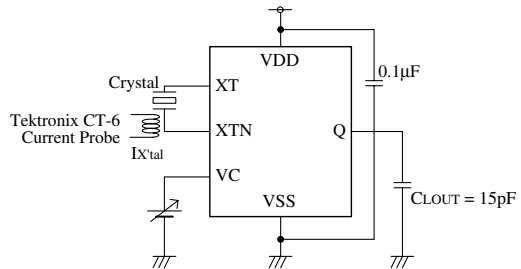

$DL = (I_{Xtal})^2 \times Re$
 DL: drive level
 I_{Xtal} : current flowing to crystal (RMS value)
 Re: crystal effective resistance

Negative Resistance

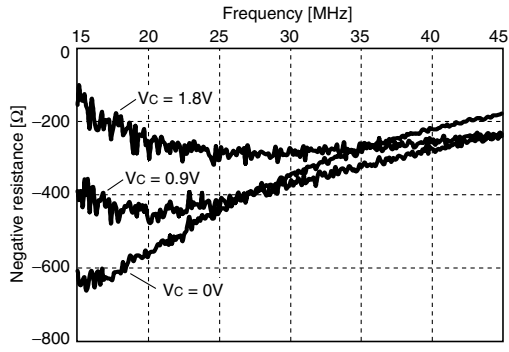

$V_{DD} = 1.8V, C_0 = 2pF, T_a = R.T.$

Note. "C0" value is set, concerning the actual crystal characteristics connected between XT and XTN. The data is measured with Agilent 4396B using NPC's original measurement jig. The values may vary with measurement jig and conditions.

Measurement circuit

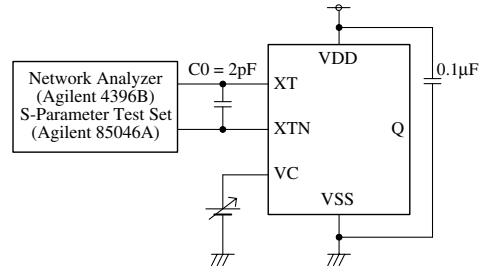

Phase Noise

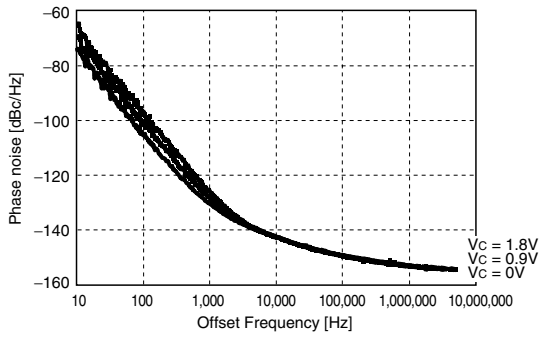

$V_{DD} = 1.8V, f_{OUT} = 27MHz, T_a = R.T.$

Measurement circuit

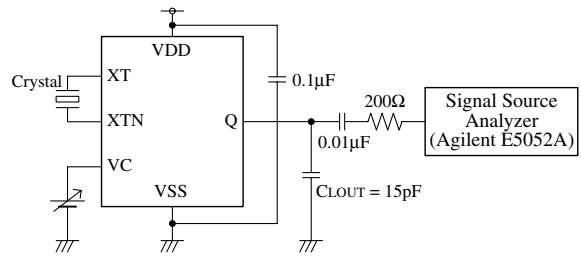

Modulation Characteristics

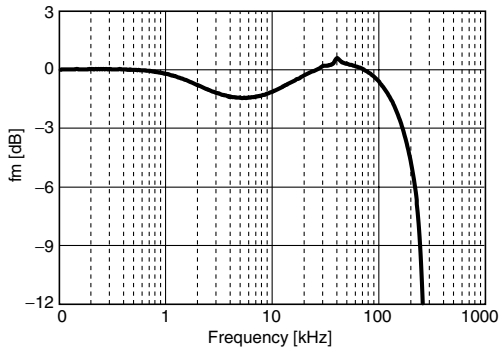

$V_{DD} = 1.8V, f_{OUT} = 27MHz, T_a = R.T.$

Measurement circuit

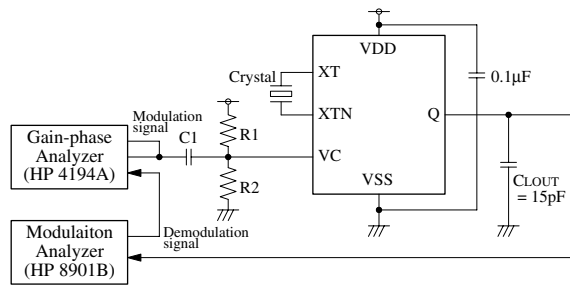

$C1 = 33\mu F, R1 = R2 = 1M\Omega$
 VC modulation signal: 100Hz to 100kHz, 0 to V_{DDp-p}

Output Waveform

Measurement equipment: Oscilloscope; DSO80604B (Agilent)

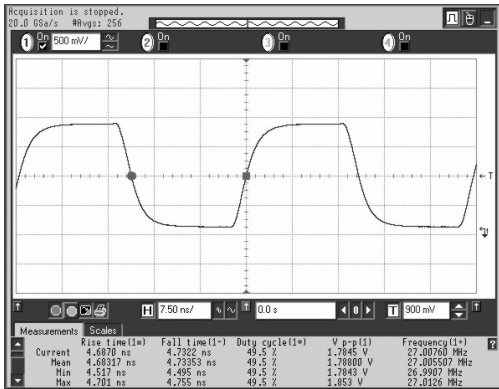

$V_{DD} = 1.8V, f_{OUT} = 27MHz, V_C = 0.5V_{DD},$
 $C_{LOAD} = 15pF, T_a = R.T.$

Measurement circuit

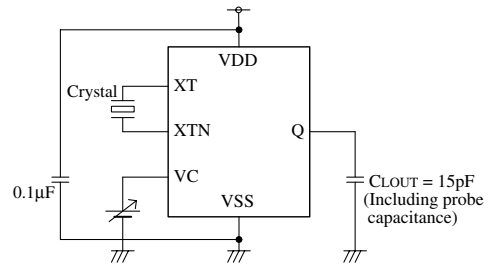

Please pay your attention to the following points at time of using the products shown in this document.

1. The products shown in this document (hereinafter "Products") are designed and manufactured to the generally accepted standards of reliability as expected for use in general electronic and electrical equipment, such as personal equipment, machine tools and measurement equipment. The Products are not designed and manufactured to be used in any other special equipment requiring extremely high level of reliability and safety, such as aerospace equipment, nuclear power control equipment, medical equipment, transportation equipment, disaster prevention equipment, security equipment. The Products are not designed and manufactured to be used for the apparatus that exerts harmful influence on the human lives due to the defects, failure or malfunction of the Products. If you wish to use the Products in that apparatus, please contact our sales section in advance.
In the event that the Products are used in such apparatus without our prior approval, we assume no responsibility whatsoever for any damages resulting from the use of that apparatus.
2. NPC reserves the right to change the specifications of the Products in order to improve the characteristics or reliability thereof.
3. The information described in this document is presented only as a guide for using the Products. No responsibility is assumed by us for any infringements of patents or other rights of the third parties which may result from its use. No license is granted by implication or otherwise under any patents or other rights of the third parties. Then, we assume no responsibility whatsoever for any damages resulting from that infringements.
4. The constant of each circuit shown in this document is described as an example, and it is not guaranteed about its value of the mass-production products.
5. In the case of that the Products in this document falls under the foreign exchange and foreign trade control law or other applicable laws and regulations, approval of the export to be based on those laws and regulations are necessary. Customers are requested appropriately take steps to obtain required permissions or approvals form appropriate government agencies.

The logo for NPC (Seiko NPC Corporation) consists of the letters 'NPC' in a bold, black, sans-serif font. The 'N' and 'P' are connected at the top, and the 'C' is positioned to the right of the 'P'.

SEIKO NPC CORPORATION

1-9-9, Hatchobori, Chuo-ku,
Tokyo 104-0032, Japan
Telephone: +81-3-5541-6501
Facsimile: +81-3-5541-6510
<http://www.npc.co.jp/>
Email: sales@npc.co.jp

NC0811BE 2010.02